

wizarPOS
☎400-608-2601

WIZARHAND Q1 智能POS终端

使用说明书



www.wizarpos.com

V1.4, 2019年8月

01 产品特点
Product Characteristics

感谢您使用上海慧银信息科技有限公司产品!
Thank you for using the
wizarPOS International Co., Ltd. Products!

WIZARHAND Q1

智能 + 安全
Intelligent Security



装箱单
Packing List 02

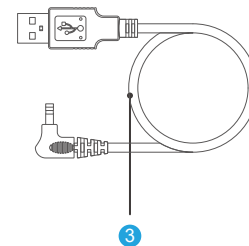
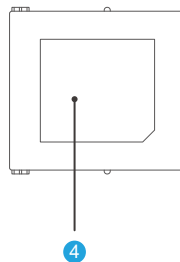
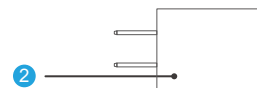
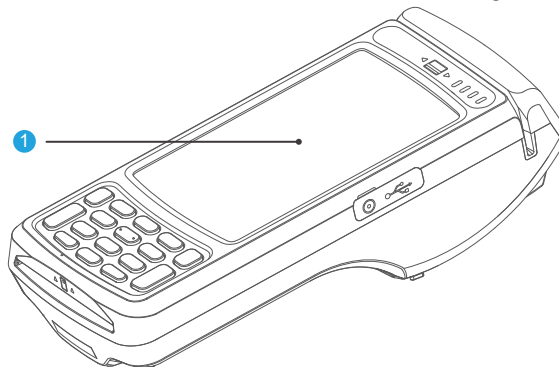

1 WIZARHAND Q1
WIZARHAND Q1

2 5V电源适配器
5V Adapter

3 充电线
DC Cable

4 7.4V锂电池
7.4V Lithium Battery

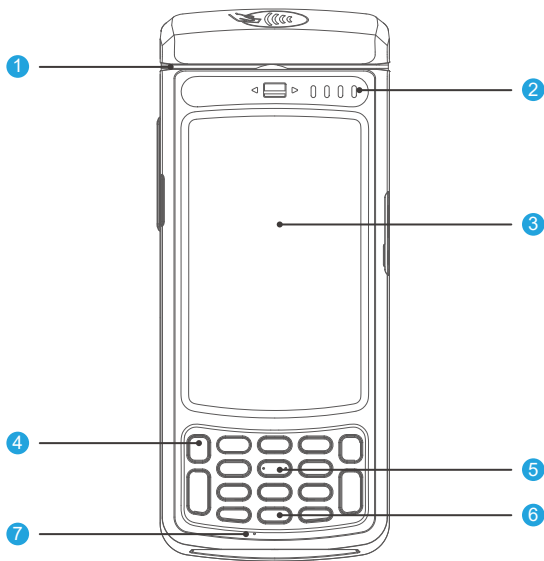

- 1 磁条卡读卡器
Magnetic Card Reader
- 2 LED状态指示灯 × 4
4 Indicators
- 3 4英寸电容式多点触摸屏
4" Capacitive Multi-touch Screen
- 4 开关键
Power Key
- 5 密码键盘
PINPAD
- 6 扫描键
Scan Key
- 7 话筒
MIC

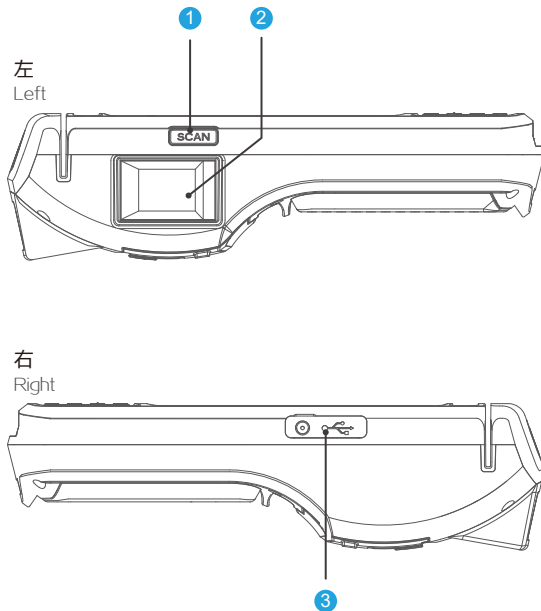

- 1 扫描键
Scan Key
- 2 按压式指纹扫描模块(选配)
Fingerprint Sensor (Select)
- 3 电源接口 & Micro-USB 接口
DC Jack & Micro-USB Port

上
Top

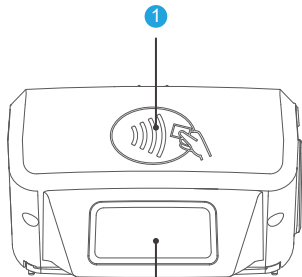

下
Bottom

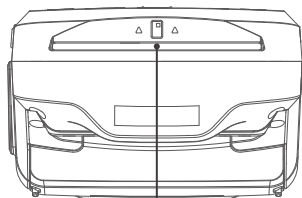

- 1 非接卡读卡区域
Contactless Card Reader
- 2 一维、二维码扫描头
Barcode and 2D Barcode Scanner
- 3 智能卡读卡器
IC Card Reader

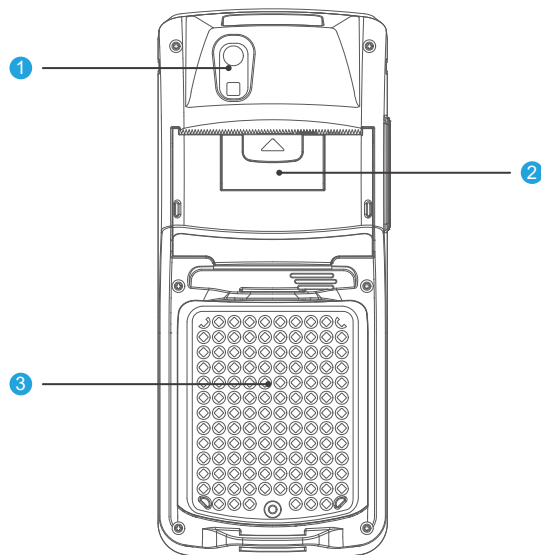

- 1 高清自动对焦摄像头
Auto-focus Camera
- 2 58mm热敏打印机
58mm Thermal Printer
- 3 电池仓盖
Battery Compartment Cover

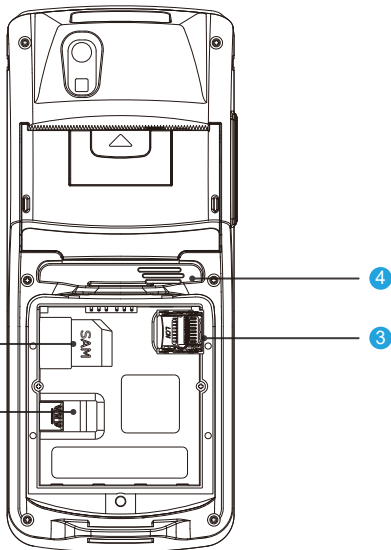

1 SAM卡槽
SAM Card Slot

2 SIM卡槽
SIM Card Slot

3 TF卡槽
TF Card Slot

4 喇叭
Speaker





1 使用前准备 (Before use)

- 使用前请先安装电池，并锁紧电池盖紧固螺钉。
Please install the battery first, and lock the screw on cover.
- 如电池电量不足，请先充电。
Please charge if the battery has not enough energy.
- 正确装入纸卷，并盖好打印机后盖。
Load the paper roll, and close the printer cover.

2 开机与关机 (Power on and off)

- 按长按“电源”键3秒钟，可开启本机。
Press “power” key for 3 seconds, you can open the POS.
启动完成后，会显示系统主界面，您可以开始操作本机。
After secure booting, it will display desktop, you can operate the POS.
- 开机状态快速按下“电源”键可点亮或熄灭屏幕显示。
You can turn on/off the LCD by quickly press the “Power” key.
- 开机状态长按“电源”键3秒钟，可开启关机菜单，按提示关闭本机。
When the POS is power on, press “power” key for 3 seconds, it will display power off menu, follow the prompts to close the POS.

3 按键说明 (The function of keys)

-  电源键：开机/关机，点亮/熄灭屏幕。
Power key: Power on / off the POS, turn on / off LCD.
-  取消键：退出应用，取消输入密码。
Cancel key: Quit APP, cancel the password input.
-  回退键：逐个删除输入的密码。
Backspace key: remove the password one by one.
-  确认键：确认输入的密码。
Enter key: Enter the password.
- 数字键及小数点键：输入金额和密码。
Numeric keys and decimal point key: key in the amount or password

f) **SCAN** 扫描键/侧扫描键: 开启条码/二维码扫描功能, 本功能需要应用支持。

Scan key / Side scan key: open the function of barcode scanning, if the APP is support.

4 系统设置 (System setup)

a) 在主界面顶部状态栏下拉, 可进入通知界面。

Pull off the status bar at the top of desktop, it will display the notification interface.

b) 点击屏幕右上角菜单图标, 可进入系统功能开关界面。

Click the menu icon in upper right corner of the screen, it will display the function switch interface.

c) 点击设置图标, 可进入本机设置界面, 请按实际需要进行设置操作。

Click the "setup" icon, it will display the setup interface. Please setup the POS if you needed.

5 支付操作 (Payment operation)

请按支付应用软件提供方的指示进行操作。

Please follow the instructions of your payment APP provider.

6 银行卡操作 (Bank card operation)

a) 请将芯片卡朝上插入智能卡槽。

Please insert IC card front upward into card reader slot.

b) 请将磁条卡的磁条朝向屏幕侧刷卡, 本机可双向刷卡。

Swipe the magnetic stripe card with magnetic stripe facing to screen, you can bi-directional swipe the card.

c) 使用非接触卡时, 请快速将卡靠近非接触卡读卡器。

Place the contactless card close to the card reader area.

规格配置	详细描述
软件平台	金融级安全的安卓平台
处理器	高性能四核CPU
内存	1G RAM、8GB Flash
显示屏	4英寸电容式多点触摸屏 (480×800分辨率)
打印机	内置高速58mm热敏打印机
摄像头	500万像素自动对焦摄像头, 带闪光灯
条码扫描	专用一维码、二维码扫描头
生物识别	按压式指纹识别模块 (选配)
安全认证	PCI PTS 4.1
磁条卡读卡器	支持ISO7811 1/2/3磁道卡, 双向刷卡
IC卡读卡器	符合ISO7816、PBOC3.0和EMV Level 1规范
非接卡读卡器	支持ISO/IEC 14443 Type A&B、Mifare卡, EMV Level 1
内置卡座	SIM×1、SAM×1、TF×1
无线通讯	GSM、CDMA2000、WCDMA、LTE、WiFi、Bluetooth
GPS	内置, 支持A-GPS、Glonass
USB接口	Micro-USB OTG, 兼容USB2.0 HS标准
电池	7.4V 2400毫安时锂离子聚合物电池
外观尺寸	183×76×50毫米
重量	450克



以上产品规格仅供参考, 产品最新信息请查阅慧银官方网站
www.wizarpos.com。

Specification	Detailed Description
Software Platform	Secure Android
Processor	Quad-Core CPU
Memory	1GB RAM, 8GB Flash
Display	4" Capacitive Multi-touch Screen (480 x 800)
Printer	High Speed 58mm Thermal Printer
Camera	5M With Auto-Focus and Flash
Scanner	Barcode and 2D Barcode
Biometric	Fingerprint Sensor (Optional)
Security	PCI PTS 4.1
MSR	ISO7811 Track 1/2/3, Bi-Direction
Chip Card	ISO 7816, PBOC3.0, EMV Level 1
Contactless	ISO/IEC 14443 Type A&B, Mifare, EMV Level 1
Slots	SIM x 1, SAM x 1, TF x 1
Communication	GSM, CDMA2000, WCDMA, LTE, WiFi, Bluetooth
GPS	A-GPS, Glonass
USB	Micro-USB OTG, USB 2.0 HS Compliant
Battery	7.4V 2400mAh Lithium-ion Polymer Battery
Dimension	183 x 76 x 50 mm
Weight	450g

All features and specifications are subject to change without notice. Contact wizarPOS website for more details.

www.wizarpos.com

👁️ 环境要求 (Environment)

-  工作温度 (Operating temperature)
-5°C~40°C (+23°F to 104°F)
-  工作湿度 (Operating humidity)
20%~85% 无冷凝 (No condensation)
-  存储温度 (Storage temperature)
-20°C~60°C (-4°F to 140°F)
-  存储湿度 (Storage humidity)
10%~90% 无冷凝 (No condensation)

👁️ 注意事项 (Attention)

- ◆ 请勿改装本机，私自改装金融POS机涉嫌违法！
Do **NOT** refit the POS, that is illegal to privately refit financial POS.
- ◆ 用户需承担自行安装第三方应用所产生的风险，包括出现兼容性错误或信息泄漏等后果。
User shall bear the risks of installation and usage of third party APPs.
- ◆ 安装过多应用可能导致系统运行迟钝。
The system will become slow due to too many APPs installed.
- ◆ 请使用干布清洁本机，不要使用稀释剂或苯等化学制剂。
Please use dry cloth to clean the POS, Do **NOT** use chemical.
- ◆ 请勿将本机长时间暴露在强烈日光之下。
Do **NOT** expose the POS under heavy sunlight for long time.
- ◆ 请勿使用尖锐硬物触摸屏幕。
Do **NOT** use sharp and hard objects to touch the screen.
- ◆ 请勿将本机及电池、充电器作为普通生活垃圾处理，请遵照当地环保法规要求回收。
Do **NOT** waste the POS, charger or battery as common household garbage. Please support recycle according to local environment rules.

⚠️ 安全警示 (Warning)

- ◆ 请使用原装电池及充电器，否则可能造成产品损坏或人身伤害。
Please use the original battery and charger, otherwise that may cause product damage or personal injury.
- ◆ 请勿把电池扔进火中，否则会导致电池起火和爆炸。
Do **NOT** put the battery into fire, otherwise it will cause explosion.
- ◆ 电池禁止浸水，电池进水后不可再次使用。
The battery is forbidden to immerse, the battery can not be used again after entering the water.
- ◆ 请勿用金属物使电池两极对接，以免电池短路，并造成设备损坏或人身伤害。
Do **NOT** short circuit battery, otherwise that will cause personal injury or battery permanent damaged.
- ◆ 如果发现电池变形或异常发热，请停止使用并更换新电池。
If battery is deformed or abnormal heat, discontinue use it and replace with new battery.
- ◆ 更换错误型号电池会有爆炸危险。
Replacing the wrong model battery may cause an explosion.

故障情况 Trouble	排查方式 Trouble shooting
无法连接移动通信网 Cannot connect the mobile network	<ul style="list-style-type: none"> ◆ 检查设置中“移动数据”功能是否已开启。 Check whether the function of “data” is open. ◆ 检查移动网络设置中，“接入点名称”的设置是否正确。 Check whether the APN is correct. ◆ 检查卡是否已开通3G数据通信功能。 Check whether the data service of SIM is active.
打印时卡纸 Paper jam	<ul style="list-style-type: none"> ◆ 打印纸重装并确认是否有褶皱。 Reload the paper roll, or check the if there is crease on paper roll. ◆ 检查打印机盖子是否盖好。 Check if the cover of printer is closed. ◆ 确认是否因上笔交易未正常撕纸导致出口卡住。 Check whether the slot is blocked by the paper of last transaction record. ◆ 检查打印轴是否丢失。 Check if the print shaft is missing.
屏幕跳屏 Display unstable	<ul style="list-style-type: none"> ◆ 充电过程中电压不稳可能会出现跳屏问题，请拔下充电器操作。 The display may be interfered by instability voltage when charging, please disconnect the plug.
点屏幕无反应 No response	<ul style="list-style-type: none"> ◆ 请重启本机，看故障是否排除。 Restart the APP or operation system.
操作反应变迟钝 Operation very slow	<ul style="list-style-type: none"> ◆ 请在设置-应用中，删除不必要的应用。 Please stop active APPs witch are not necessary.

👁️ 产品保修政策 (Product warranty policy)

本公司按照国家“产品质量法”的相关要求提供售后服务。请仔细阅读以下保修条款以获得本公司的保修服务。

WizarPOS provide after-sales service according to relative laws. Please read the following warranty terms.

1. 主机和充电器保修期限为一年，电池保修期限六个月。

Warranty period: one year for POS and charger, and 6 months for battery cell.

2. 保修期内，产品出现非人为损坏的故障，本公司可提供免费维修或部件更换服务。

In warranty period, wizarPOS provide free repair/replace service, if the product has non artificial product failures.

3. 用户需要维修本产品时，请拨打慧银公司售后服务热线。

Welcome to call our service hotline when you needed.

4. 用户需要凭“产品保修卡”获得保修服务，请真实填写保修卡上内容。

Please show product warranty card with true information.

👁️ 保修限制条款 (Warranty limitation clause)

若出现以下任何一种情况，将导致产品失去保修资格。此时，用户仍可获得本公司的维修服务，但要支付相应费用。

Situations due to following reasons are not covered under warranty policies. While we can provide charge service.

1. 未经本公司许可，用户擅自进行拆卸或维修。

Without our permission, the POS is unauthorized maintenance by user.

2. 用户自行修改操作系统。

The OS of POS is unauthorized changed by user.

3. 用户自行安装使用第三方软件造成产品功能故障。

The trouble is caused by the third party APP which is installed by user.

4. 因摔落、挤压、击打、浸水、灼烧等不当使用造成的损坏。

Damage due to improper use which like falling, squeeze, hit, soaking, burning...

5. 无保修卡，或保修卡上所填信息不真实。

No warranty card, or cannot provide true information in card.

6. 保修期满。

Expiry of guarantee period.

7. 存在法律规定的其他不予保修情形。

Exist other reason which is forbidden by laws.

👁️ 环保说明 (Description of environmental protection)

环保使用期限标识和产品中有害物质的名称及含量。

List of harmful substances in the product and logo of environment-friendly use period.

	<p>左图为本型号产品的环保使用期限标志。该图标表示： 电子电气产品中含有的有害物质在正常使用的条件下，不会发生外泄或突变，电子电气产品用户使用该产品不会对环境造成污染或对其人身、财产造成损害的期限。</p> <p>This is environment-friendly use period logo of the product. This logo means that in this period the product will not leak harmful substances in normal usage.</p>
---	--

部件名称 Part	有害物质 Harmful substances					
	铅 Pb	汞 Hg	镉 Cd	六价铬 Cr(VI)	多溴联苯 PBB	多溴二苯醚 PBDE
显示屏组件 LCD and TP Module	○	○	○	○	○	○
外壳与键盘 Housing and keypad	○	○	○	○	○	○
印刷电路板 及元器件 PCBA and components	×	○	○	○	○	○
配件 Accessories	×	○	○	○	○	○

本表格依据 SJ/T 11364 的规定编制。

○：表示该有害物质在该部件所有均质材料中的含量均在 GB/T 26572 规定的限量要求以下。

×：表示该有害物质至少在该部件的某一均质材料中的含量超出 GB/T 26572 规定的限量要求。注：表格中标有 × 的部件都符合国家《电器电子产品有害物质限制使用管理办法》要求，以及欧盟 RoHS 法规要求。

This table is made according to requirement of SJ/T 11364.

○ means the harmful substance concentration in the parts is under the limits in GB/T 26572.

× means the harmful substance concentration of one or more homogeneous materials in the parts is exceeded the limits in GB/T 26572.

NOTE: Parts which marked × are compliant to China RoHS Regulation and EU RoHS Directive.

维修日期 Repair date	维修内容 Repair content

售后服务热线：400-608-2601

After-Sale Service Hotline: 400-608-2601

如需了解更多信息，请登录本公司官网 www.wizarpos.com

For more information, please log on to the company's official website

<http://www.wizarpos.com>